

NOTES: UNLESS OTHERWISE SPECIFIED

1. DIMENSIONS ARE IN INCHES (mm).

Top Cabinet ships separately from the lower frame

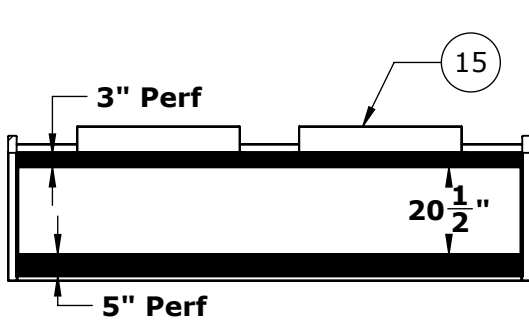
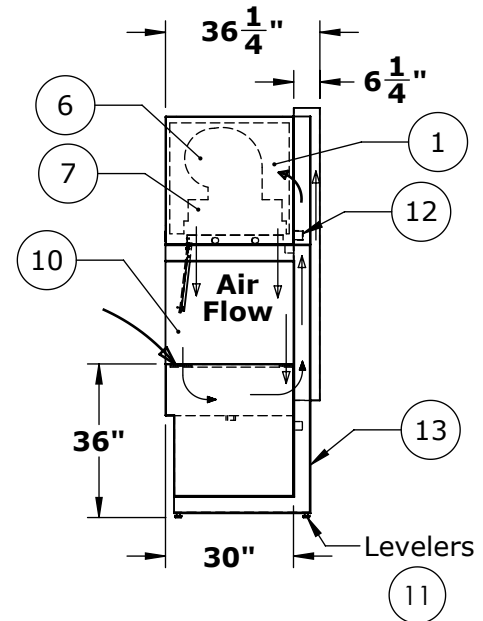
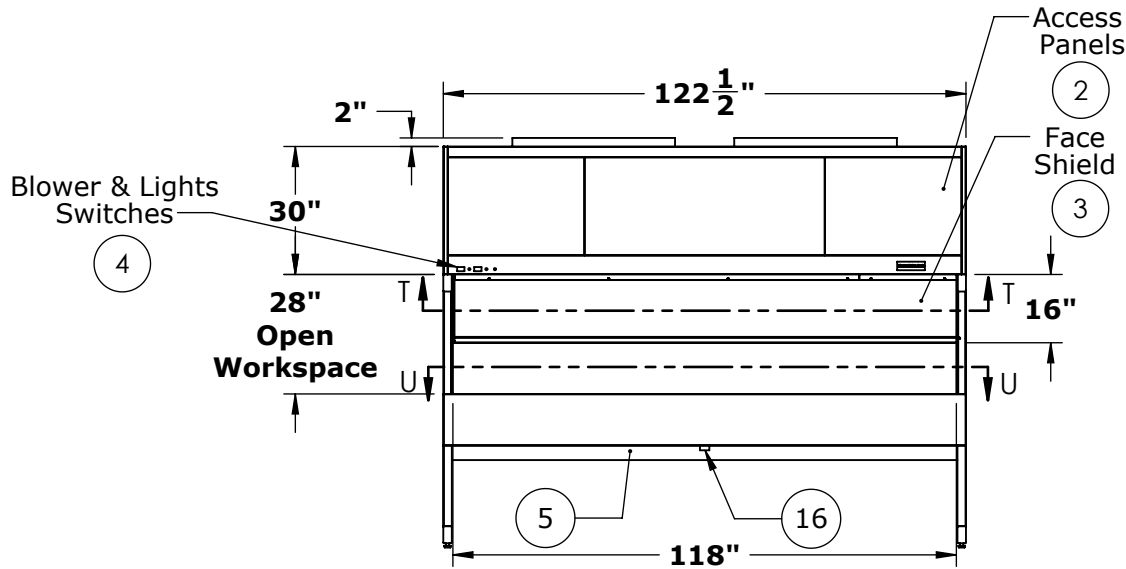
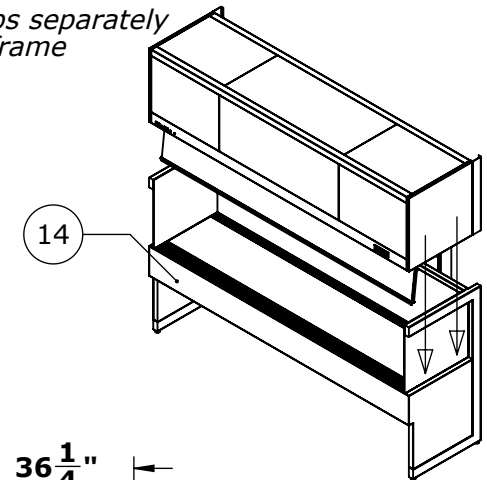
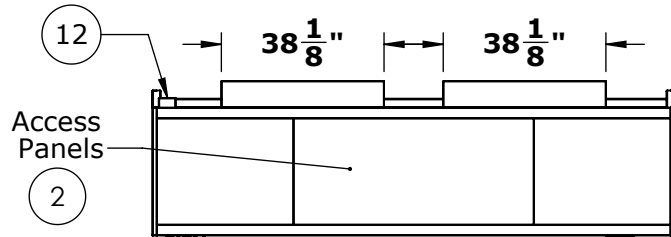

Work Surface
SECTION U-U

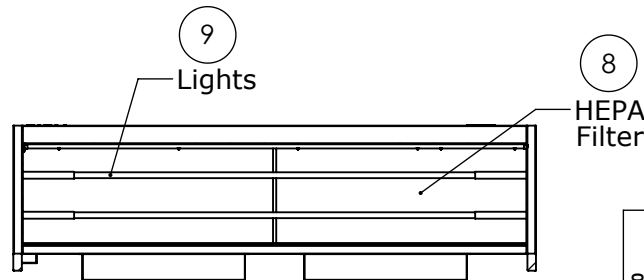

SECTION T-T



© COPYRIGHT 2010 CLEAN AIR PRODUCTS	Clean Air PRODUCTS	8605 WYOMING AVENUE NORTH • MINNEAPOLIS, MN 55445 800-423-9728 • ph: 763-425-9122 • fax: 763-425-2004 www.cleanairproducts.com		
	DESCRIPTION.	Vertical Flow Clean Bench CAP412-10T30-36H-ER-SST		
	QUOTE NO.			
	DO NOT SCALE	DATE DRAWN 09/07/2012	QUOTE FORM 035511	REV 1

NOTES: UNLESS OTHERWISE SPECIFIED

1. DIMENSIONS ARE IN INCHES (mm).

Notes:

1. Top Cabinet, 16ga CRS with White Powder Coat Finish
2. Blower and Filter Access Panels, Front and Rear
(Field Personnel Can Relocate These In Order To Mount Prefilters In The Front)
3. Front Face Shield, Hinged 1/4" Polycarbonate, 12" Opening
4. Control Panel, Blower and Light Switch, Circuit Breakers
5. Back Panel, 18ga Stainless Steel
6. Double Blowers, 1/2HP, 120V, 60Hz
7. Supply Plenum, metal over top of HEPA, Flex duct to blower
8. HEPA, 99.99% on 0.3 micron particles, Aluminum anodized frame
9. Lights, Fluorescent Lamps, F96T12 (2x)
10. End Shields, Clear Polycarbonate
11. Leg Leveling Glides, Adjustable +/- 1/2"
12. Electrical Junction Box, (120V, 60Hz, 13.75 FLA)
13. Lower Support Frame, "C" Style, HRS with White Powder Coat
14. Stainless Steel Exhaust Plenum with 16ga Stainless Steel Work Surface
15. Exhaust Duct, Stainless Steel - Customer Supplied Exhaust must Provide a Minimum of 1500 CFM Total
16. Plenum Drain, 1-1/2" NPT Stainless Steel - Customer to Provide Plug if Needed

Optional:

17. Power Cord - 14 ft Long
18. 304 #4 Finish Stainless Steel Back Panel
19. 304 #4 Finish Stainless Steel Side Panel
20. 304 #4 Finish Stainless Steel "C"-Frame
21. 304 #4 Finish Stainless Steel Top Cabinet
22. Low Profile - 20" Tall Top Cabinet (Normally 30" Tall)
23. ULPA Filters - ISO Class 4, Fed Std 209E 10

Shipping Note:

1. Top Cabinet Shipped
Separate from "C"-Frame

© COPYRIGHT 2010 CLEAN AIR PRODUCTS	Clean Air PRODUCTS 8605 WYOMING AVENUE NORTH • MINNEAPOLIS, MN 55445 800-423-9728 • ph: 763-425-9122 • fax:763-425-2004 www.cleanairproducts.com			
	DESCRIPTION. Vertical Flow Clean Bench CAP412-10T30-36H-ER-SST			
	QUOTE NO.			
	DO NOT SCALE			
	DATE DRAWN 09/07/2012	QUOTE FORM 035511	REV 1	SHEET 2 of 2