

NOTES: UNLESS OTHERWISE SPECIFIED
 1. DIMENSIONS ARE IN INCHES (mm).

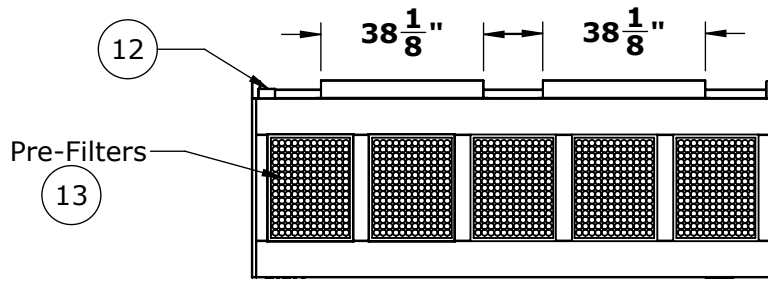

Top Cabinet ships separately
 from the lower frame

Prefilters can be relocated
 to the front of unit.
 Leave minimum of 4 inches of
 clearance from filter face

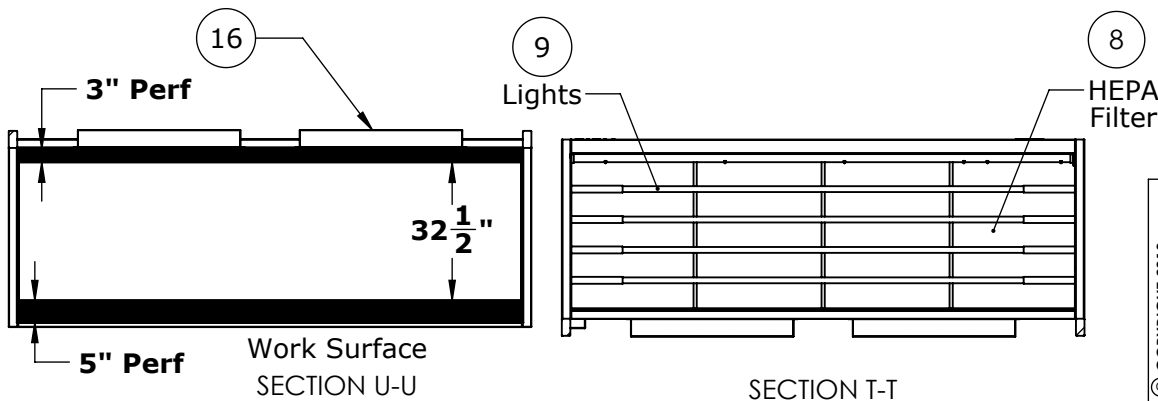
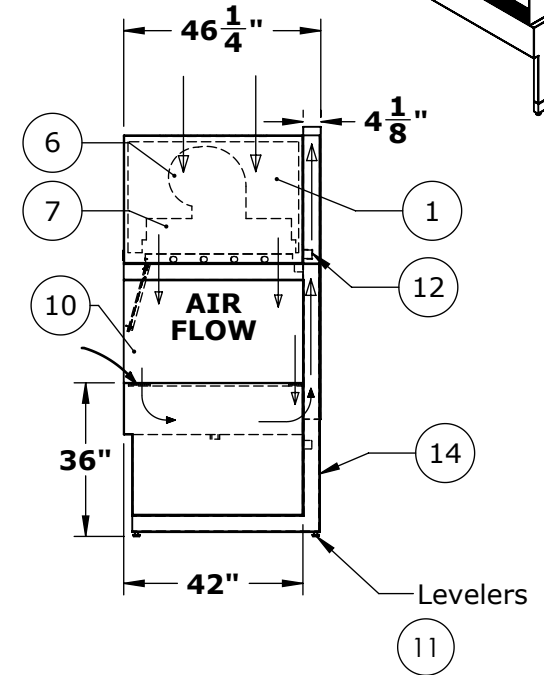
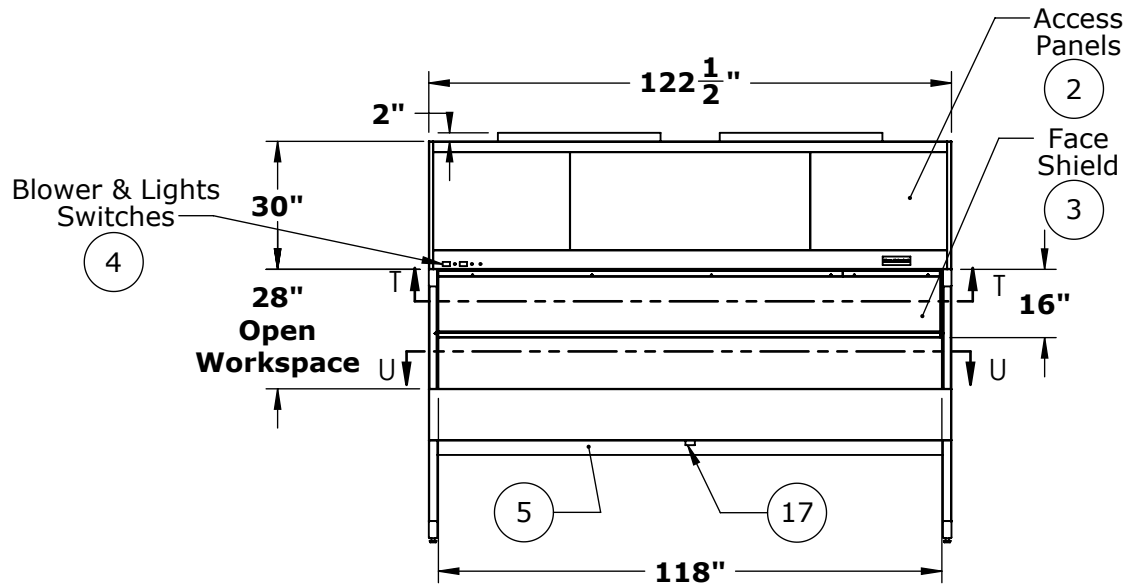
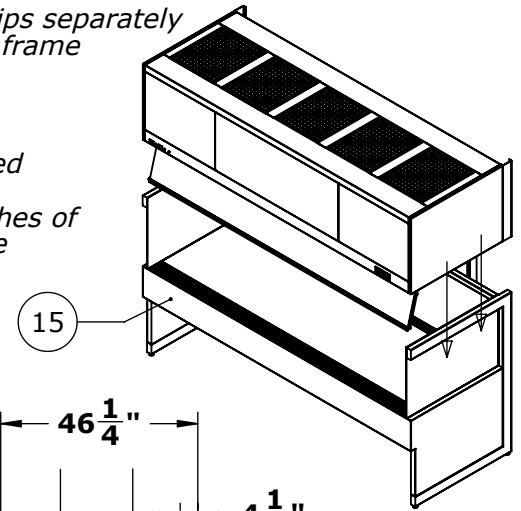

© COPYRIGHT 2010 CLEAN AIR PRODUCTS	Clean Air PRODUCTS		8605 WYOMING AVENUE NORTH • MINNEAPOLIS, MN 55445 800-423-9728 • ph: 763-425-9122 • fax: 763-425-2004 www.cleanairproducts.com		
	DESCRIPTION.		Vertical Flow Clean Bench CAP412-10T42-36H-EU-SST		
	QUOTE NO.		DO NOT SCALE		
	DATE DRAWN 09/05/2012	QUOTE FORM 035460	REV 1	SHEET	

NOTES: UNLESS OTHERWISE SPECIFIED

1. DIMENSIONS ARE IN INCHES (mm).

Notes:

1. Top Cabinet, 16ga CRS with White Powder Coat Finish
2. Blower and Filter Access Panels, Front and Rear
(Field Personnel Can Relocate These In Order To Mount Prefilters In The Front)
3. Front Face Shield, Hinged 1/4" Polycarbonate, 12" Opening
4. Control Panel, Blower and Light Switch, Circuit Breakers
5. Back Panel, 18ga Stainless Steel
6. Double Blowers, 3/4HP, 120V, 60Hz
7. Supply Plenum, metal over top of HEPA, Flex duct to blower
8. HEPA, 99.99% on 0.3 micron particles, Aluminum anodized frame
9. Lights, Fluorescent Lamps, F96T12 (4x)
10. End Shields, Clear Polycarbonate
11. Leg Leveling Glides, Adjustable +/- 1/2"
12. Electrical Junction Box, (120V, 60Hz, 23.1FLA)
13. Prefilters, 20x25x1 Glass Fiber (5x) Note: Can Be Relocated in the Field
14. Lower Support Frame, "C" Style, HRS with White Powder Coat
15. Stainless Steel Exhaust Plenum with 16ga Stainless Steel Work Surface
16. Exhaust Duct, Stainless Steel - Customer Supplied Exhaust must Provide a Minimum of 4200 CFM Total
17. Plenum Drain, 1-1/2" NPT Stainless Steel - Customer to Provide Plug if Needed

Optional:

18. Power Cord - 14 ft Long
19. 304 #4 Finish Stainless Steel Side Panel
20. 304 #4 Finish Stainless Steel "C"-Frame
21. 304 #4 Finish Stainless Steel Top Cabinet
22. Low Profile - 20" Tall Top Cabinet (Normally 30" Tall)
23. ULPA Filters - ISO Class 4, Fed Std 209E 10

Shipping Note:

1. Top Cabinet Shipped
Separate from "C"-Frame

© COPYRIGHT 2010 CLEAN AIR PRODUCTS	Clean Air PRODUCTS 8605 WYOMING AVENUE NORTH • MINNEAPOLIS, MN 55445 800-423-9728 • ph: 763-425-9122 • fax:763-425-2004 www.cleanairproducts.com		
	DESCRIPTION. Vertical Flow Clean Bench CAP412-10T42-36H-EU-SST		
	QUOTE NO.		
	DO NOT SCALE		
DATE DRAWN 09/05/2012	QUOTE FORM 035460	REV 1	SHEET 2 of 2