

NOTES: UNLESS OTHERWISE SPECIFIED

1. DIMENSIONS ARE IN INCHES (mm).

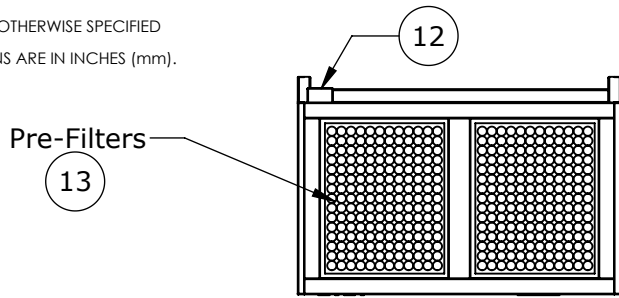

Prefilters can be relocated to the front or back of unit. Leave minimum of 4 inches of clearance from filter face

Top Cabinet ships separate from the lower frame

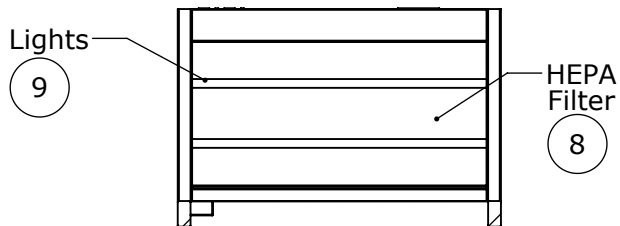
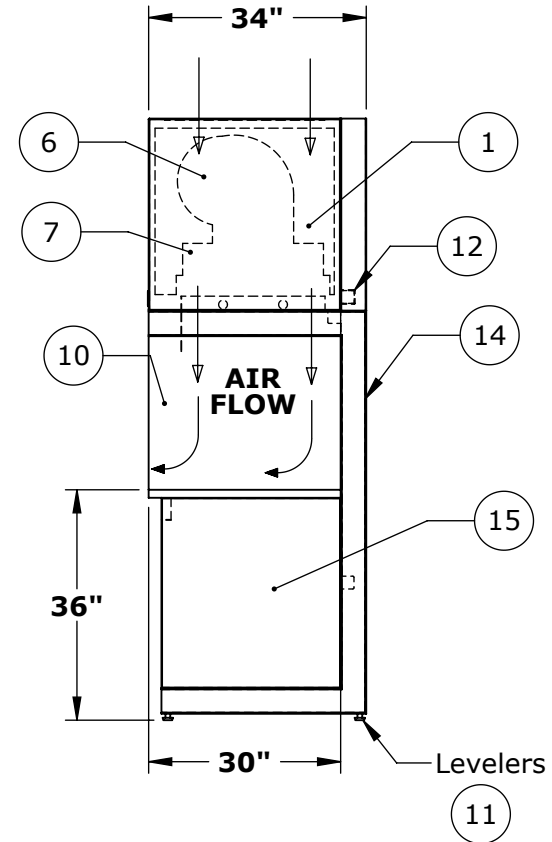
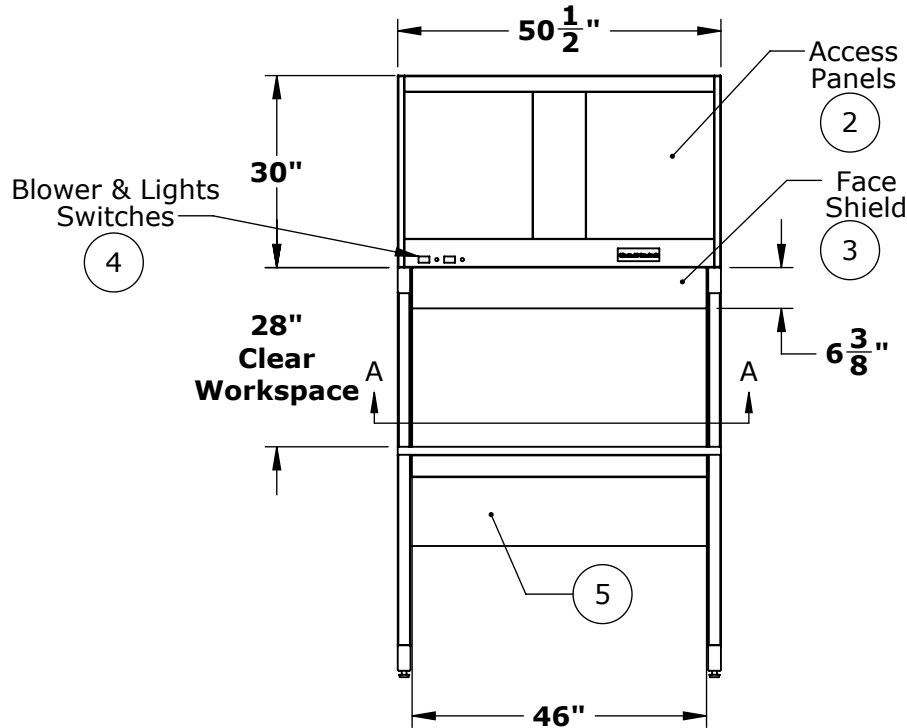
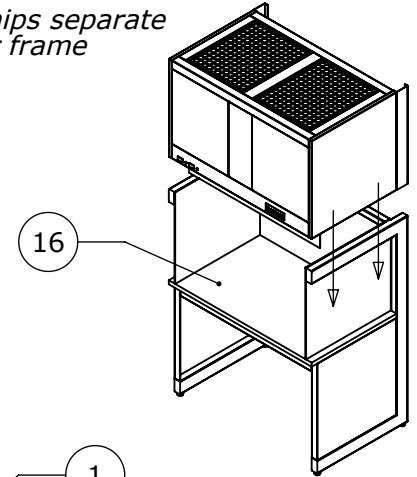

SECTION A-A



© COPYRIGHT 2010 CLEAN AIR PRODUCTS	Clean Air PRODUCTS	8605 WYOMING AVENUE NORTH • MINNEAPOLIS, MN 55445 800-423-9728 • ph: 763-425-9122 • fax: 763-425-2004 www.cleanairproducts.com
	DESCRIPTION.	Vertical Flow Clean Bench CAP412-4T30-36H-WO
	QUOTE NO.	
	DO NOT SCALE	DATE DRAWN 04/16/2012
	REV	SHEET
	1	1 of 2

NOTES: UNLESS OTHERWISE SPECIFIED

1. DIMENSIONS ARE IN INCHES (mm).

Notes:

1. Top Cabinet, 16ga CRS with White Powder Coat Finish
2. Blower and Filter Access Panels, Front and Rear
(Field Personnel Can Relocate These In Order To Mount Prefilters In The Front)
3. Front Face Shield, 80mil Clear Flexible Vinyl
4. Control Panel, Blower and Light Switch, Circuit Breakers
5. Back Panel, 18ga. Vinyl Coated Steel
6. Single Blower, 1/3HP, 120V, 60Hz
7. Supply Plenum, metal over top of HEPA, Flex duct to blower
8. HEPA, 99.99% on 0.3 micron particles, Aluminum anodized frame
9. Lights, Fluorescent Lamps, F48T12 (2x)
10. End Shields, Clear Polycarbonate
11. Leg Leveling Glides, Adjustable +/- 1/2"
12. Electrical Junction Box, (120V, 60Hz, 5.42 FLA)
13. Prefilters, 20x25x1 Glass Fiber (2x) Note: Can Be Field Relocated in the Field
14. Lower Support Frame, "C" Style, HRS with White Powder Coat
15. Side Work Surface Supports, Vinyl Coated Steel
16. White Formica Work Surface

Optional:

17. Power Cord - 14 ft Long
18. 304 #4 Finish Stainless Steel Back Panel
19. 304 #4 Finish Stainless Steel Side Panel
20. 304 #4 Finish Stainless Steel "C"-Frame
21. 304 #4 Finish Stainless Steel Top Cabinet
22. Low Profile - 20" Tall Top Cabinet (Normally 30" Tall)
23. ULPA Filters - ISO Class 4, Fed Std 209E 10

Shipping Note:

1. Top Cabinet Shipped
Separate from "C"-Frame

© COPYRIGHT 2010 CLEAN AIR PRODUCTS	Clean Air PRODUCTS 8605 WYOMING AVENUE NORTH • MINNEAPOLIS, MN 55445 800-423-9728 • ph: 763-425-9122 • fax: 763-425-2004 www.cleanairproducts.com			
	DESCRIPTION. Vertical Flow Clean Bench CAP412-4T30-36H-WO			
	QUOTE NO.			
	DO NOT SCALE			
	DATE DRAWN 04/16/2012	QUOTE FORM 035226	REV 1	SHEET 2 of 2