

NOTES: UNLESS OTHERWISE SPECIFIED
 1. DIMENSIONS ARE IN INCHES (mm).

Top Cabinet ships separate
 from the lower frame

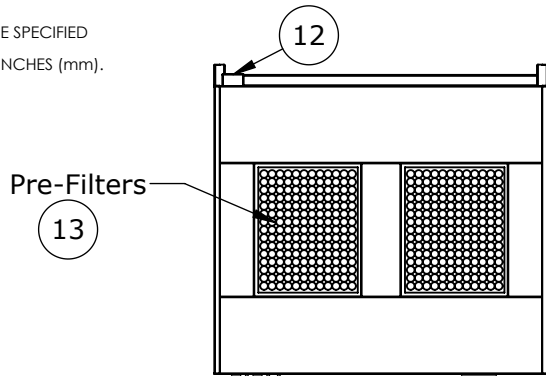

Prefilters can be relocated
 to the front or back of unit.
 Leave minimum of 4 inches of
 clearance from filter face

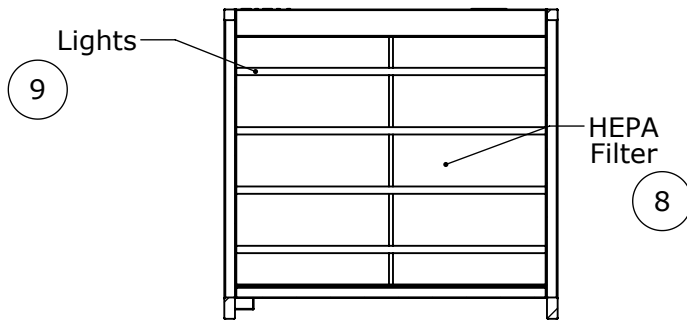
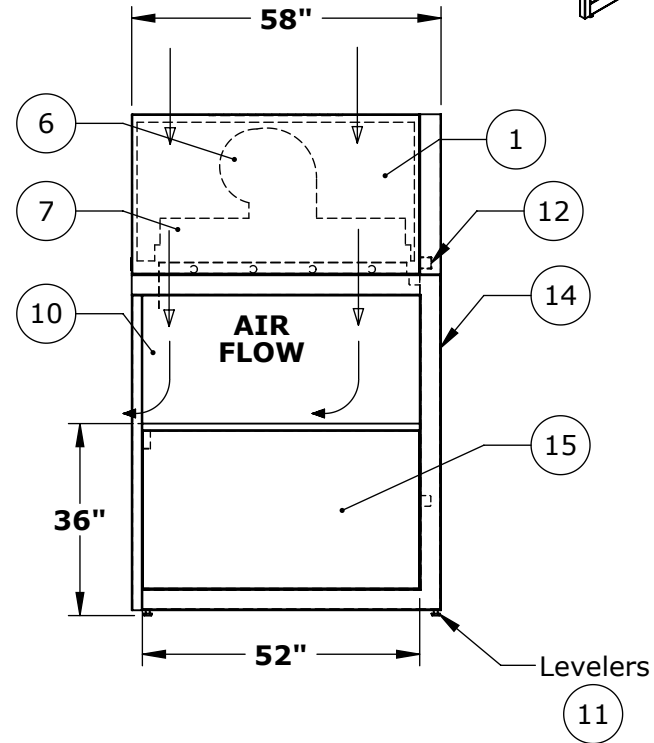
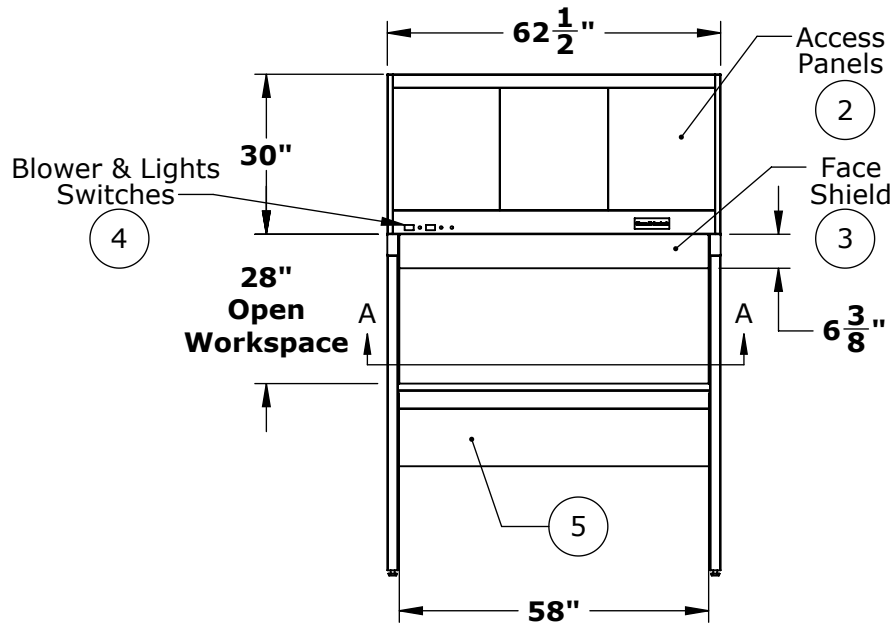
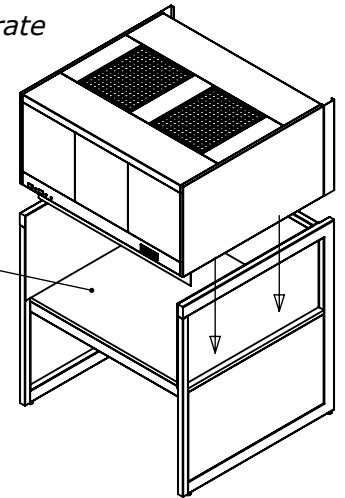

SECTION A-A



© COPYRIGHT 2010 CLEAN AIR PRODUCTS	Clean Air PRODUCTS	8605 WYOMING AVENUE NORTH • MINNEAPOLIS, MN 55445 800-423-9728 • ph: 763-425-9122 • fax: 763-425-2004 www.cleanairproducts.com
	DESCRIPTION.	Vertical Flow Clean Bench CAP412-5T54-36H-WO
	QUOTE NO.	
	DO NOT SCALE	DATE DRAWN 04/16/2012
	REV	SHEET
	1	1 of 2

NOTES: UNLESS OTHERWISE SPECIFIED

1. DIMENSIONS ARE IN INCHES (mm).

Notes:

1. **Top Cabinet, 16ga CRS with White Powder Coat Finish**
2. **Blower and Filter Access Panels, Front and Rear
(Field Personnel Can Relocate These In Order To Mount Prefilters In The Front)**
3. **Front Face Shield, 80mil Clear Flexible Vinyl**
4. **Control Panel, Blower and Light Switch, Circuit Breakers**
5. **Back Panel, 18ga. Vinyl Coated Steel**
6. **Double Blowers, 1/2HP, 120V, 60Hz**
7. **Supply Plenum, metal over top of HEPA, Flex duct to blower**
8. **HEPA, 99.99% on 0.3 micron particles, Aluminum anodized frame**
9. **Lights, Fluorescent Lamps, F60T12 (4x)**
10. **End Shields, Clear Polycarbonate**
11. **Leg Leveling Glides, Adjustable +/- 1/2"**
12. **Electrical Junction Box, (120V, 60Hz, 14.46 FLA)**
13. **Prefilters, 20x25x1 Glass Fiber (2x) Note: Can Be Field Relocated in the Field**
14. **Lower Support Frame, "C" Style, HRS with White Powder Coat**
15. **Side Work Surface Supports, Vinyl Coated Steel**
16. **White Formica Work Surface**

Optional:

17. **Power Cord - 14 ft Long**
18. **304 #4 Finish Stainless Steel Back Panel**
19. **304 #4 Finish Stainless Steel Side Panel**
20. **304 #4 Finish Stainless Steel "C"-Frame**
21. **304 #4 Finish Stainless Steel Top Cabinet**
22. **Low Profile - 20" Tall Top Cabinet (Normally 30" Tall)**
23. **ULPA Filters - ISO Class 4, Fed Std 209E 10**

Shipping Note:

1. **Top Cabinet Shipped
Separate from "C"-Frame**

© COPYRIGHT 2010 CLEAN AIR PRODUCTS	Clean Air PRODUCTS 8605 WYOMING AVENUE NORTH • MINNEAPOLIS, MN 55445 800-423-9728 • ph: 763-425-9122 • fax:763-425-2004 www.cleanairproducts.com		
	DESCRIPTION. Vertical Flow Clean Bench CAP412-5T54-36H-WO		
	QUOTE NO.		
	DO NOT SCALE		
DATE DRAWN 04/16/2012	QUOTE FORM 035222	REV 1	SHEET 2 of 2