

NOTES: UNLESS OTHERWISE SPECIFIED
 1. DIMENSIONS ARE IN INCHES (mm).

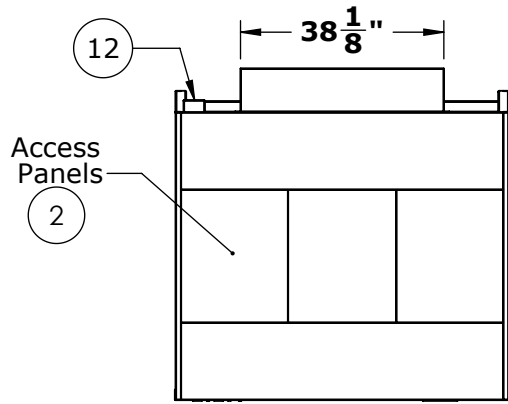

Top Cabinet ships separately
 from the lower frame

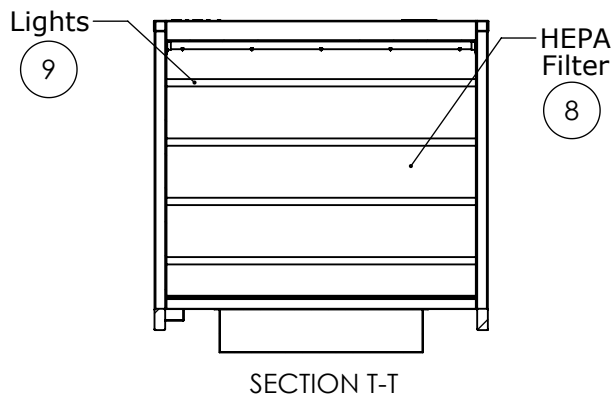
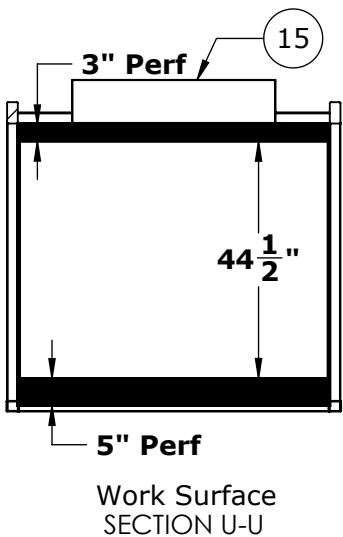
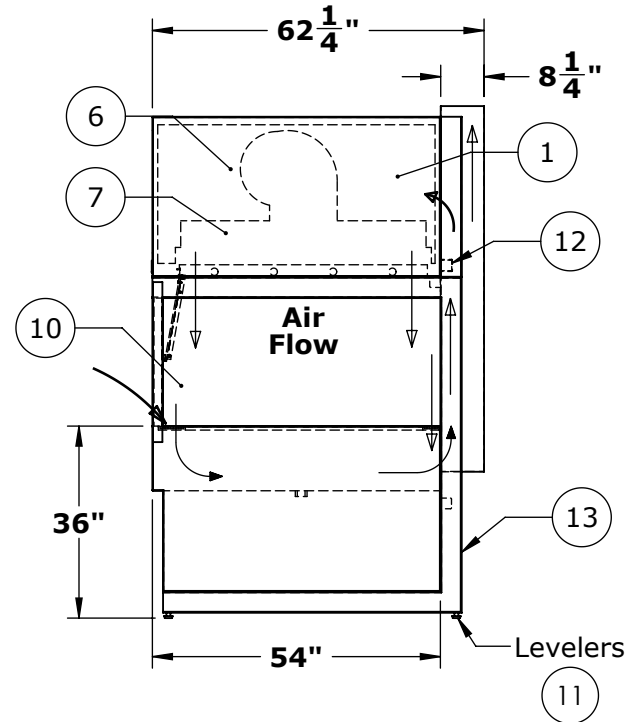
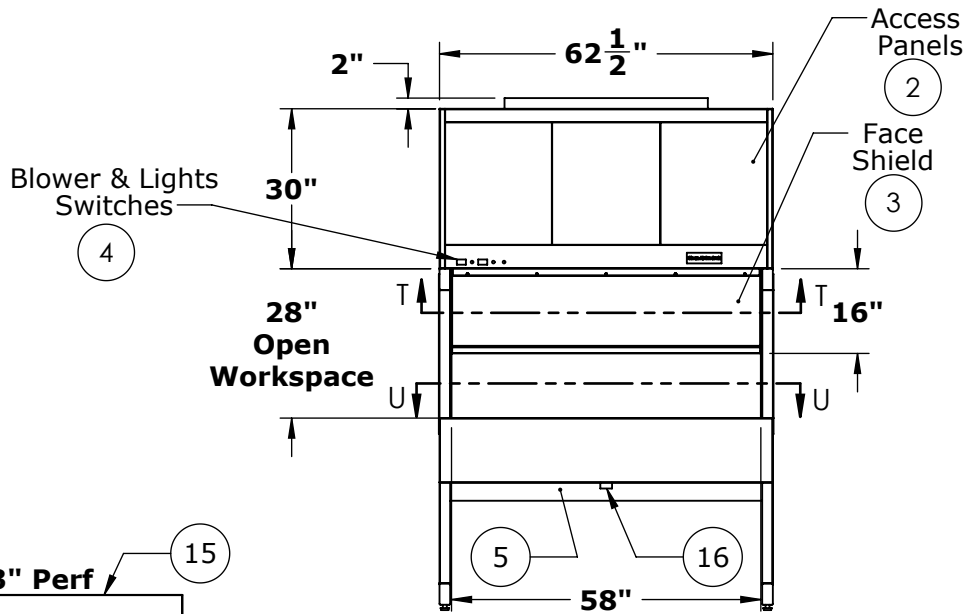
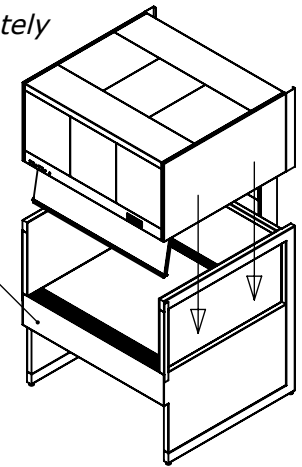

© COPYRIGHT 2010 CLEAN AIR PRODUCTS	Clean Air PRODUCTS	8605 WYOMING AVENUE NORTH • MINNEAPOLIS, MN 55445 800-423-9728 • ph: 763-425-9122 • fax: 763-425-2004 www.cleanairproducts.com
	DESCRIPTION.	Vertical Flow Clean Bench CAP412-5T54-36H-ER-SST
	QUOTE NO.	
	DO NOT SCALE	DATE DRAWN 09/07/2012
	REV 1	SHEET 1 of 2

NOTES: UNLESS OTHERWISE SPECIFIED

1. DIMENSIONS ARE IN INCHES (mm).

Notes:

1. **Top Cabinet, 16ga CRS with White Powder Coat Finish**
2. **Blower and Filter Access Panels, Front and Rear
(Field Personnel Can Relocate These In Order To Mount Prefilters In The Front)**
3. **Front Face Shield, Hinged 1/4" Polycarbonate, 12" Opening**
4. **Control Panel, Blower and Light Switch, Circuit Breakers**
5. **Back Panel, 18ga Stainless Steel**
6. **Double Blowers, 1/2HP, 120V, 60Hz**
7. **Supply Plenum, metal over top of HEPA, Flex duct to blower**
8. **HEPA, 99.99% on 0.3 micron particles, Aluminum anodized frame**
9. **Lights, Fluorescent Lamps, F60T12 (4x)**
10. **End Shields, Clear Polycarbonate**
11. **Leg Leveling Glides, Adjustable +/- 1/2"**
12. **Electrical Junction Box, (120V, 60Hz, 14.46 FLA)**
13. **Lower Support Frame, "C" Style, HRS with White Powder Coat**
14. **Stainless Steel Exhaust Plenum with 16ga Stainless Steel Work Surface**
15. **Exhaust Duct, Stainless Steel - Customer Supplied Exhaust must Provide a Minimum of 800 CFM Total**
16. **Plenum Drain, 1-1/2" NPT Stainless Steel - Customer to Provide Plug if Needed**

Optional:

17. **Power Cord - 14 ft Long**
18. **304 #4 Finish Stainless Steel Back Panel**
19. **304 #4 Finish Stainless Steel Side Panel**
20. **304 #4 Finish Stainless Steel "C"-Frame**
21. **304 #4 Finish Stainless Steel Top Cabinet**
22. **Low Profile - 20" Tall Top Cabinet (Normally 30" Tall)**
23. **ULPA Filters - ISO Class 4, Fed Std 209E 10**

Shipping Note:

1. **Top Cabinet Shipped
Separate from "C"-Frame**

© COPYRIGHT 2010 CLEAN AIR PRODUCTS	Clean Air PRODUCTS 8605 WYOMING AVENUE NORTH • MINNEAPOLIS, MN 55445 800-423-9728 • ph: 763-425-9122 • fax:763-425-2004 www.cleanairproducts.com		
	DESCRIPTION. Vertical Flow Clean Bench CAP412-5T54-36H-ER-SST		
	QUOTE NO.		
	DO NOT SCALE		
DATE DRAWN 09/07/2012	QUOTE FORM 035520	REV 1	SHEET 2 of 2