

NOTES: UNLESS OTHERWISE SPECIFIED

1. DIMENSIONS ARE IN INCHES (mm).

Top Cabinet ships separate from the lower frame

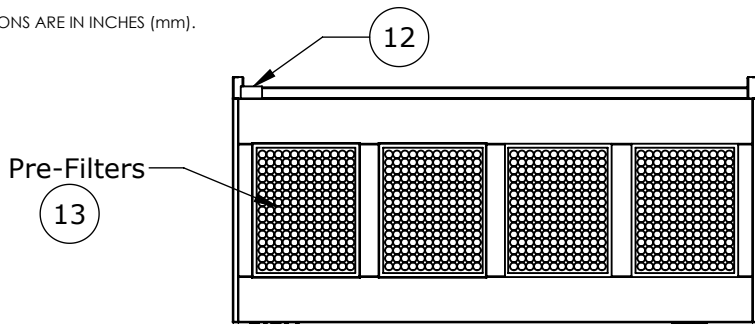

Prefilters can be relocated to the front or back of unit. Leave minimum of 4 inches of clearance from filter face

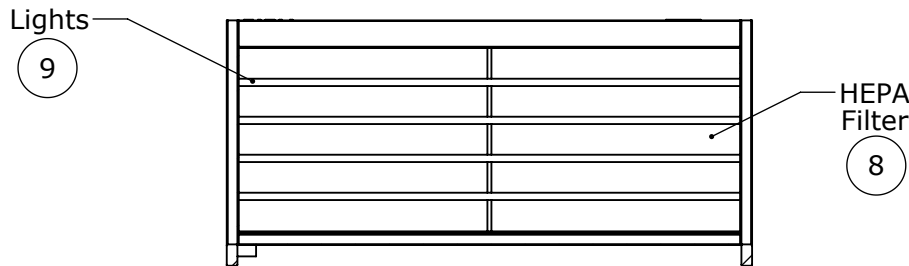
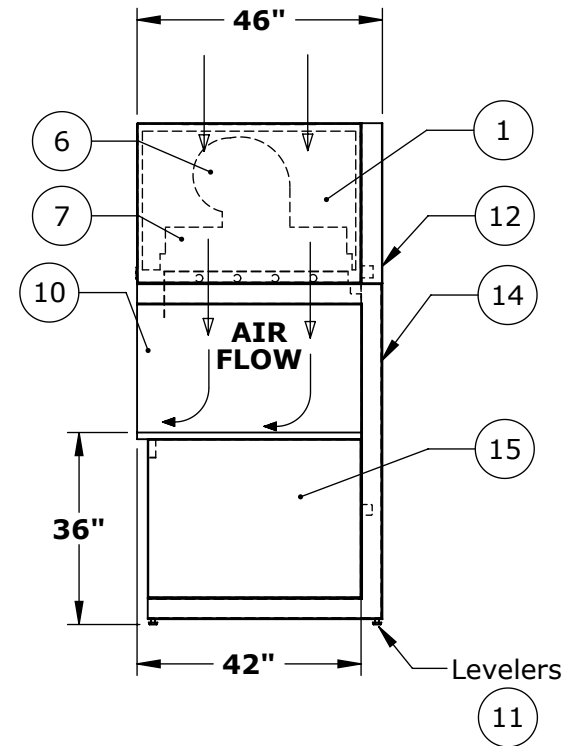
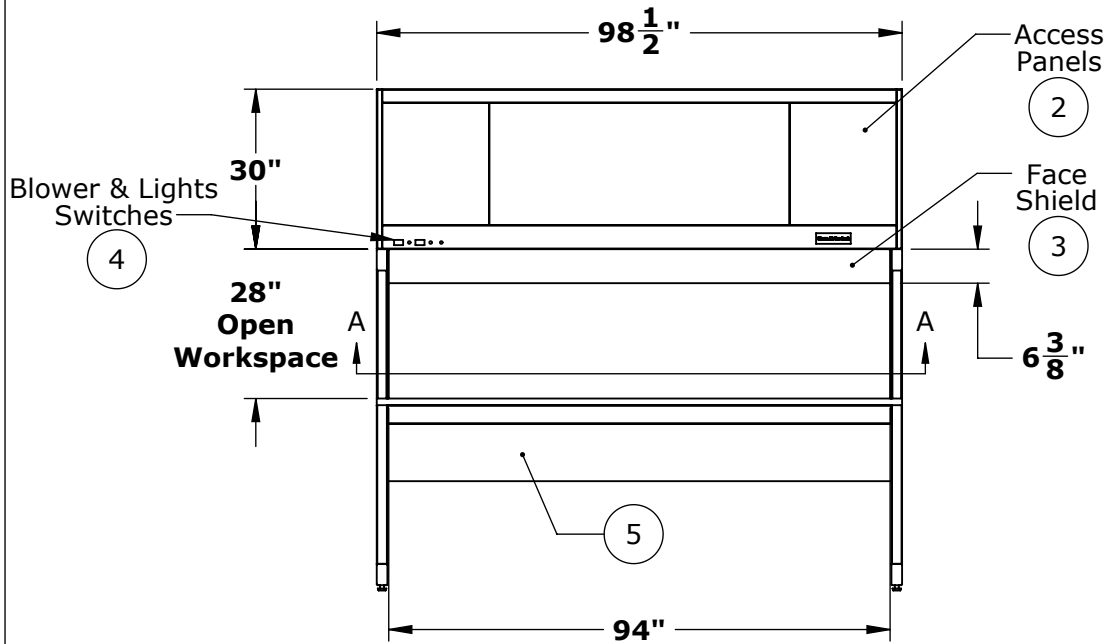
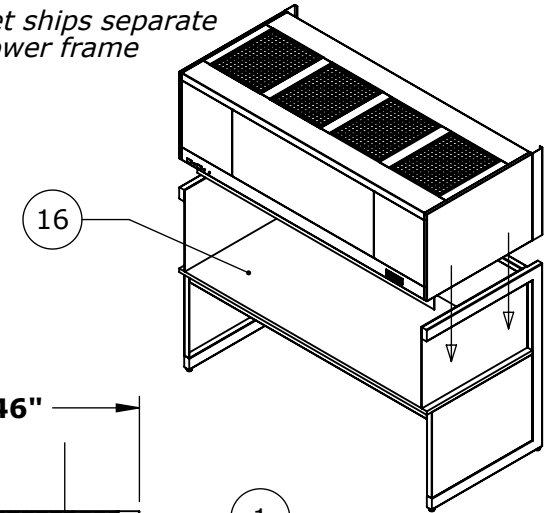

SECTION A-A



© COPYRIGHT 2010 CLEAN AIR PRODUCTS	Clean Air PRODUCTS	8605 WYOMING AVENUE NORTH • MINNEAPOLIS, MN 55445 800-423-9728 • ph: 763-425-9122 • fax: 763-425-2004 www.cleanairproducts.com		
	DESCRIPTION.	Vertical Flow Clean Bench CAP412-8T42-36H-WO		
	QUOTE NO.			
	DO NOT SCALE	DATE DRAWN 04/16/2012	QUOTE FORM 030989	REV 1

NOTES: UNLESS OTHERWISE SPECIFIED

1. DIMENSIONS ARE IN INCHES (mm).

Notes:

1. **Top Cabinet, 16ga CRS with White Powder Coat Finish**
2. **Blower and Filter Access Panels, Front and Rear
(Field Personnel Can Relocate These In Order To Mount Prefilters In The Front)**
3. **Front Face Shield, 80mil Clear Flexibile Vinyl**
4. **Control Panel, Blower and Light Switch, Circuit Breakers**
5. **Back Panel, 18ga. Vinyl Coated Steel**
6. **Double Blowers, 1/2HP, 120V, 60Hz**
7. **Supply Plenum, metal over top of HEPA, Flex duct to blower**
8. **HEPA, 99.99% on 0.3 micron particles, Aluminum anodized frame**
9. **Lights, Fluorescent Lamps, F96T12 (4x)**
10. **End Shields, Clear Polycarbonate**
11. **Leg Leveling Glides, Adjustable +/- 1/2"**
12. **Electrical Junction Box, (120V, 60Hz, 15.1 FLA)**
13. **Prefilters, 20x25x1 Glass Fiber (4x) Note: Can Be Field Relocated in the Field**
14. **Lower Support Frame, "C" Style, HRS with White Powder Coat**
15. **Side Work Surface Supports, Vinyl Coated Steel**
16. **White Formica Work Surface**

Optional:

17. **Power Cord - 14 ft Long**
18. **304 #4 Finish Stainless Steel Back Panel**
19. **304 #4 Finish Stainless Steel Side Panel**
20. **304 #4 Finish Stainless Steel "C"-Frame**
21. **304 #4 Finish Stainless Steel Top Cabinet**
22. **Low Profile - 20" Tall Top Cabinet (Normally 30" Tall)**
23. **ULPA Filters - ISO Class 4, Fed Std 209E 10**

Shipping Note:

1. **Top Cabinet Shipped
Separate from "C"-Frame**

© COPYRIGHT 2010 CLEAN AIR PRODUCTS	Clean Air PRODUCTS 8605 WYOMING AVENUE NORTH • MINNEAPOLIS, MN 55445 800-423-9728 • ph: 763-425-9122 • fax:763-425-2004 www.cleanairproducts.com			
	DESCRIPTION. Vertical Flow Clean Bench CAP412-8T42-36H-WO			
	QUOTE NO.			
	DO NOT SCALE			
	DATE DRAWN 04/16/2012	QUOTE FORM 030989	REV 1	SHEET 2 of 2