

NOTES: UNLESS OTHERWISE SPECIFIED

1. DIMENSIONS ARE IN INCHES (mm).

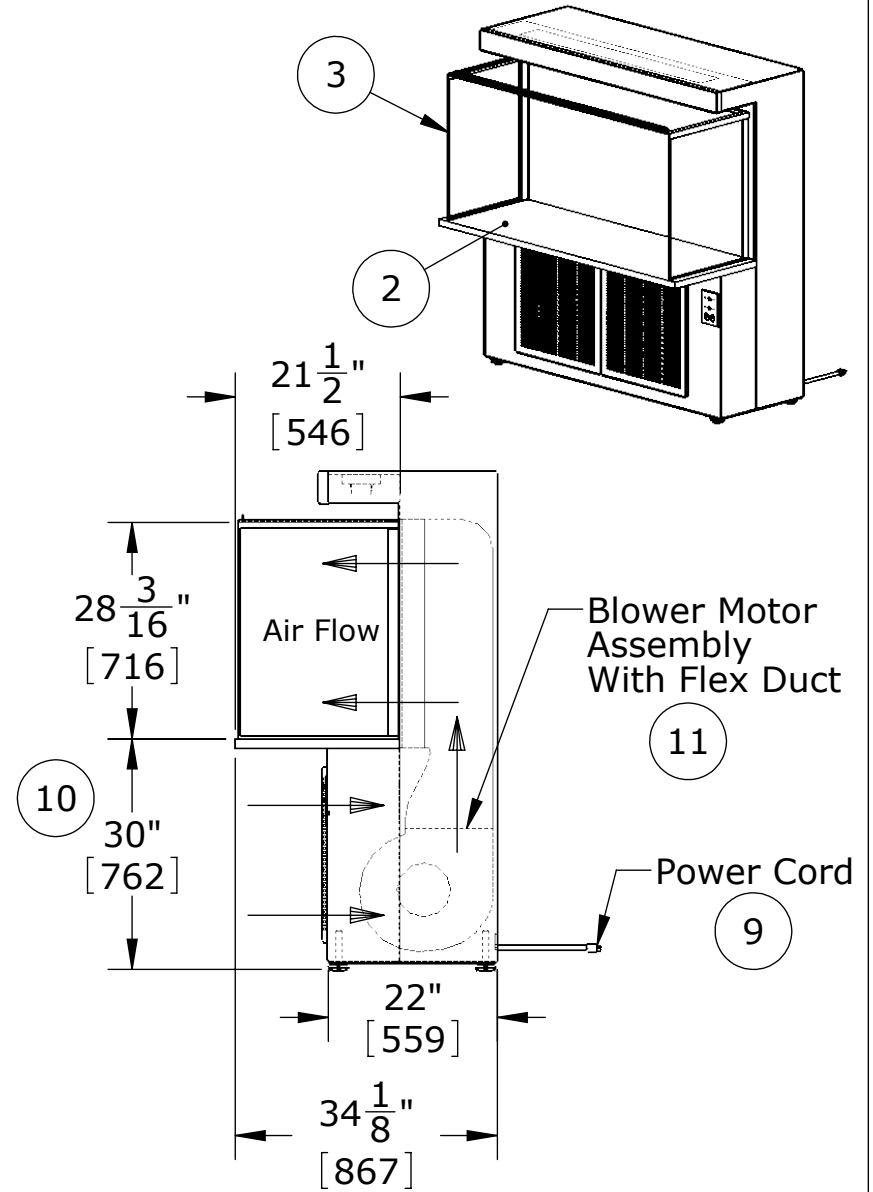
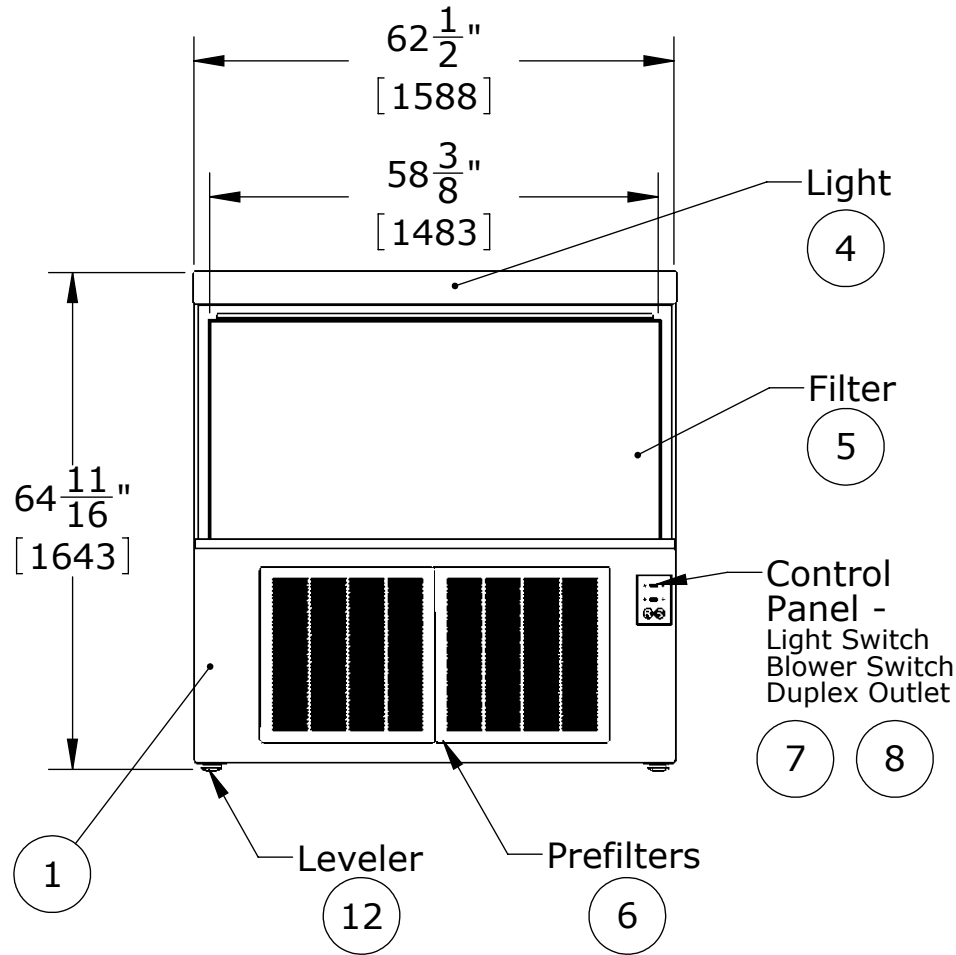

© COPYRIGHT 2010 CLEAN AIR PRODUCTS	Clean Air PRODUCTS 8605 WYOMING AVENUE NORTH • MINNEAPOLIS, MN 55445 800-423-9728 • ph: 763-425-9122 • fax: 763-425-2004 www.cleanairproducts.com		
	DESCRIPTION. Horizontal Flow Clean Bench CAP301-530-30H		
	QUOTE NO.		
	DO NOT SCALE		
DATE DRAWN 11/16/2012	QUOTE FORM 037667	REV 2	SHEET 1 of 2

NOTES: UNLESS OTHERWISE SPECIFIED

1. DIMENSIONS ARE IN INCHES (mm).

Options:

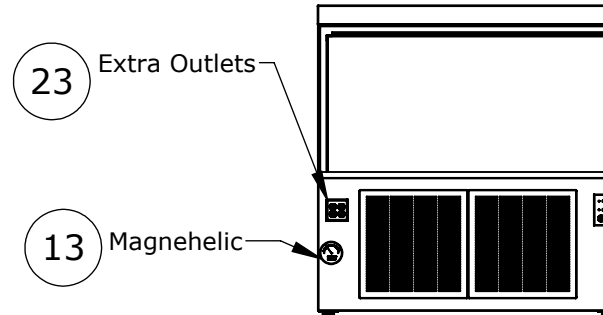

Standard Features:

1. Heavy Gauge White Vinyl Clad Steel Construction
2. White Plastic Laminate Table Top Material
3. Clear Polycarbonate Hood Panels
4. Fluorescent Light - T8 Lamps
5. Front Removable HEPA- 99.99% on 0.3 Micron Filter (Expanded Steel, Epoxy Painted, Screen On Final Filter Face)
6. Fiberglass Pre-filter Behind Hinged Louvered Grill
7. Electrical Service: Convenience Receptacle (4 Amps Available), 120V, 1-Phase, 3 Wire, With Power Cord, 10.69 A FLA
8. Blower & Light Switch
9. Power Cord (5-15P)
10. Table Top Height: 30" from Floor +/- 1/2" With Leg Adjustment
11. Blower Motor Assembly With Flex Duct
12. Adjustable Leg Leveling Glides

Options:

13. Magnehelic Gage
14. Stainless Steel Work Surface
15. Conductive Plastic Laminate Table Top
16. Ion Bar System
17. Grill on HEPA (Removable)
18. Anti-Static Polycarbonate Hood Panels
19. Safety Glass Hood Panels
20. Safety Glass Top & Stainless Hood Panels
21. Deeper Work Surface (27-1/2" & 33-1/2")
22. ULPA - 99.999% on 0.12 Micron Filter
23. Extra Service Receptacle-Separate 15A Power Cord

© COPYRIGHT 2010 CLEAN AIR PRODUCTS	Clean Air PRODUCTS	8605 WYOMING AVENUE NORTH • MINNEAPOLIS, MN 55445 800-423-9728 • ph: 763-425-9122 • fax:763-425-2004 www.cleanairproducts.com		
	DESCRIPTION.	Horizontal Flow Clean Bench CAP301-530-30H		
	QUOTE NO.			
	DO NOT SCALE	DATE DRAWN 11/16/2012	QUOTE FORM 037667	REV 2