

NOTES: UNLESS OTHERWISE SPECIFIED

1. DIMENSIONS ARE IN INCHES (mm).

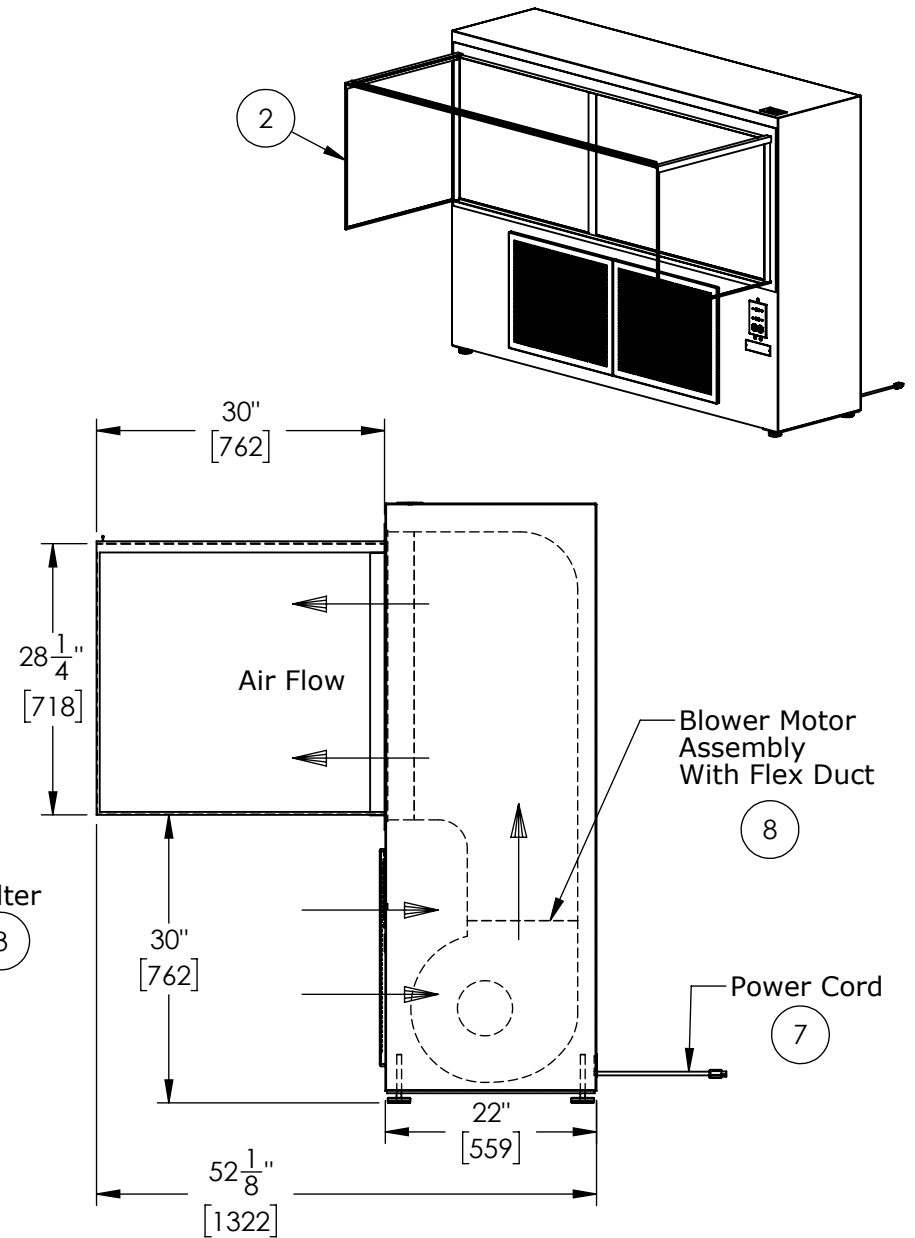
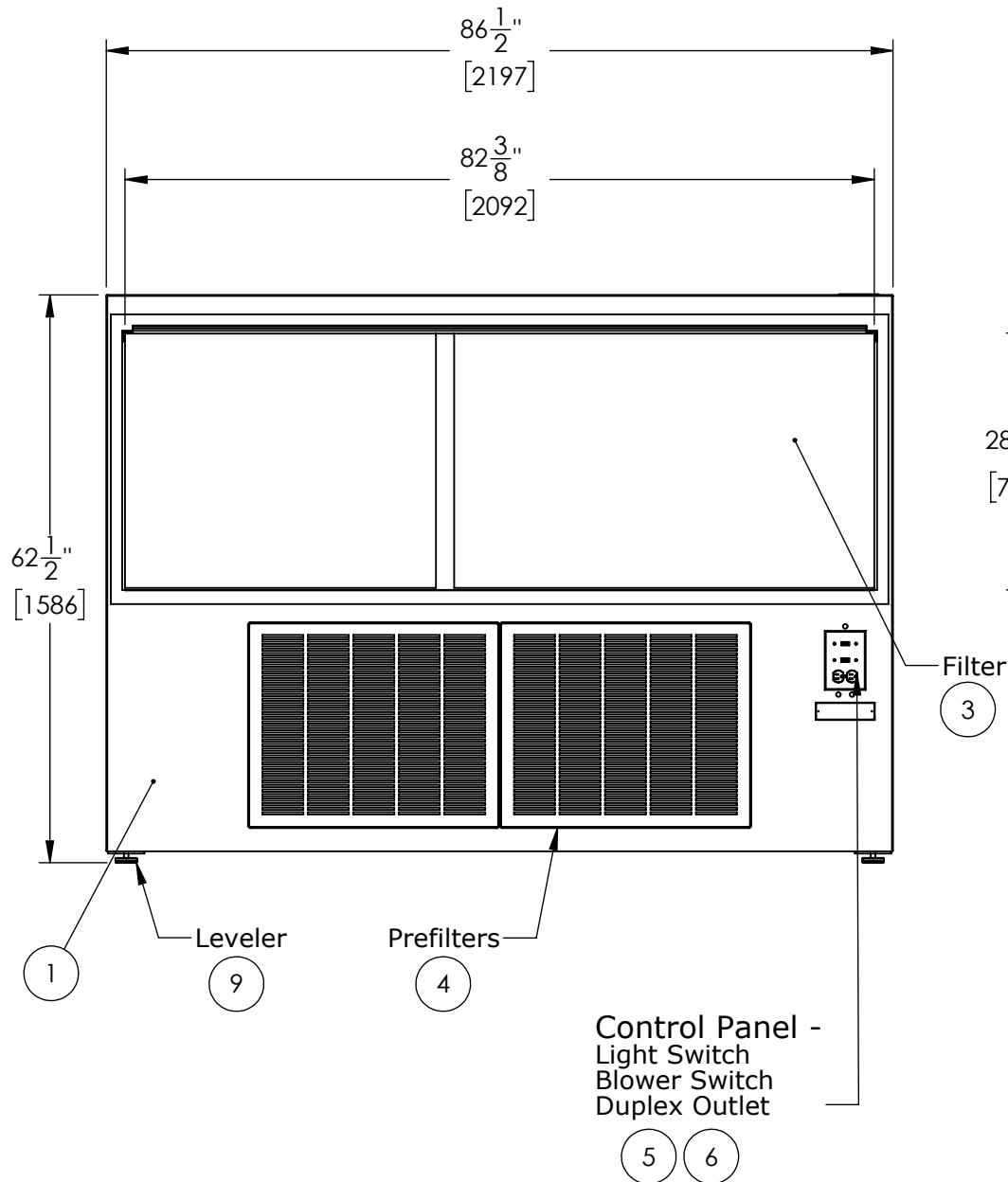

© COPYRIGHT 2010 CLEAN AIR PRODUCTS	Clean Air PRODUCTS 8605 WYOMING AVENUE NORTH • MINNEAPOLIS, MN 55445 800-423-9728 • ph: 763-425-9122 • fax: 763-425-2004 www.cleanairproducts.com		
	DESCRIPTION. Horizontal Flow Clean Bench CAP303-730-30H		
	QUOTE NO.		
	DO NOT SCALE		
DATE DRAWN 12/17/2012	QUOTE FORM 038352	REV 1	SHEET 1 of 2

OPTIONS:

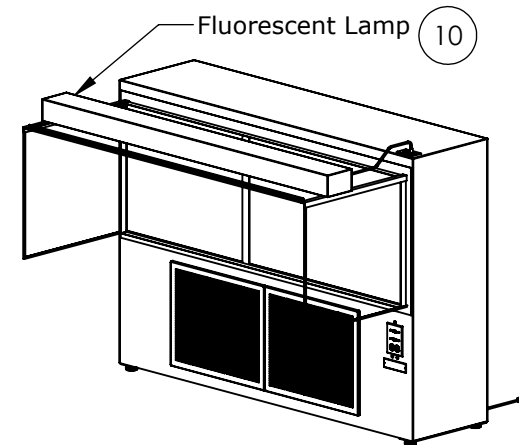
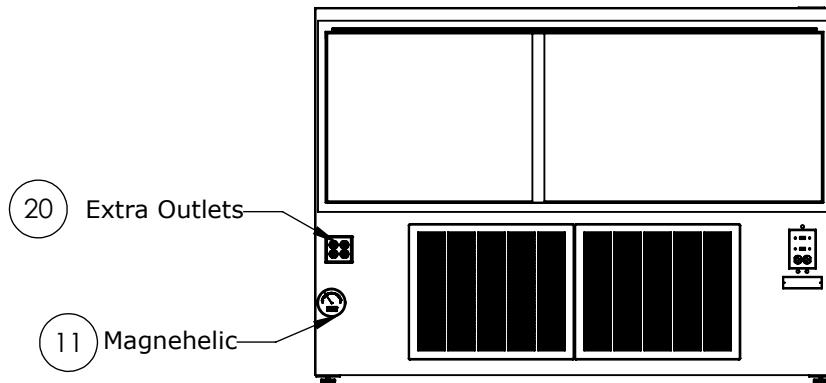

Standard Features:

1. Heavy Gauge White Vinyl Clad Steel Construction
2. Clear Polycarbonate Hood Panels: 30" from Floor +/- 1/2" With Leg Adjustment
3. Front Removable HEPA- 99.99% on 0.3 Micron Filter (Expanded Steel, Epoxy Painted, Screen On Final Filter Face)
4. Fiberglass Pre-filter Behind Hinged Louvered Grill
5. Electrical Service: Convenience Receptacle (4 Amps Available), 120V, 1-Phase, 3 Wire, With Power Cord, 15.29 A FLA
6. Blower & Light Switch
7. Power Cord (5-20P)
8. Blower Motor Assembly With Flex Duct
9. Adjustable Leg Leveling Glides

Options:

10. Fluorescent Light - T8 Lamps
11. Magnehelic Gage
12. Conductive Plastic Laminate Table Top
13. Ion Bar System
14. Grill on HEPA (Removable)
15. Anti-Static Polycarbonate Hood Panels
16. Safety Glass Hood Panels
17. Safety Glass Top & Stainless Hood Panels
18. Deeper Hood Area (36",42",48")
19. ULPA - 99.999% on 0.12 Micron Filter
20. Extra Service Receptacle-Separate 15A Power Cord

NOTES: UNLESS OTHERWISE SPECIFIED

1. DIMENSIONS ARE IN INCHES (mm).

© COPYRIGHT 2010 CLEAN AIR PRODUCTS	Clean Air PRODUCTS		8605 WYOMING AVENUE NORTH • MINNEAPOLIS, MN 55445 800-423-9728 • ph: 763-425-9122 • fax:763-425-2004 www.cleanairproducts.com			
	DESCRIPTION.		Horizontal Flow Clean Bench CAP303-730-30H			
	QUOTE NO.					
	DO NOT SCALE		DATE DRAWN 12/17/2012	QUOTE FORM 038352	REV 1	SHEET 2 of 2